

# 1.6 Collimated and telecentric backlight

Influence of the lighting angle

Wavelengths

Optical filters

Flash vs. continuous

Fluorescence applications

Lighting systems for the reading and verification of codes

The diffuse backlight lighting introduced in chapter 1.5 utilises the principle of the Lambertian scatterer\* to generate a constant radiance over the spatially extended lighting field. The light has no preferred direction of propagation and scatters evenly and homogeneously in all directions. Although required for many applications, this can pose a problem during precise measurement work, for example.

For spatially highly extended objects and round outer edges, non-directional lighting generates a partial shadow. Instead of a binary transition from white to black in the image, the result is a grey gradient over several pixels. This makes determination of the exact edge location more difficult.

**Backlight diffuse**

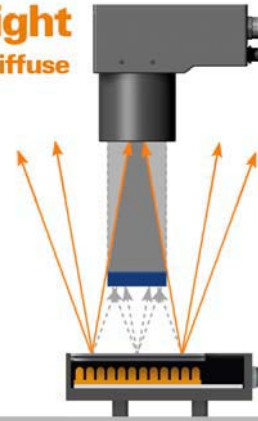

View video:



Video can be viewed at <http://www.iimag.de/lumimax/wissenswertes/video-durchlicht-diffus.html>

**Backlight collimated**

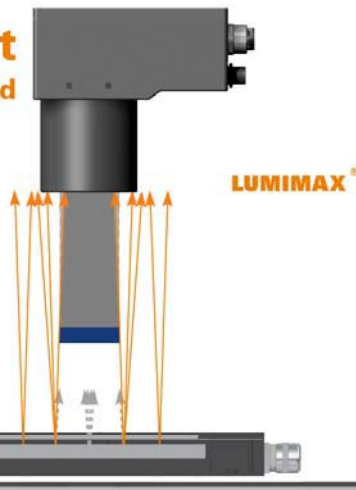

View video:



Video can be viewed at <http://www.iimag.de/lumimax/wissenswertes/video-durchlicht-kollimiert.html>

To solve this problem, we can work with directed, homogeneous, backlight lighting. With this type of lighting, the beam angle of the light is reduced by using special optical films. This very nearly approximates collimation. The effect achieved with backlighting is similar to that obtained by telecentric lighting. The light rays from the lighting are significantly more directed and achieve a more precise image of object edges. Edge probing is consequently more exact than with diffuse backlight. For deep objects and objects with convex edges in particular, this can optimise the determination of the exact edge location and improve the accuracy of the machine vision system.

Collimated backlight lighting also has advantages when working with transparent and semi-transparent test objects. The directed rays of light are

refracted more directly by edges and irregularities. These therefore appear as pronounced areas of darkness against a bright background. This simplifies the detection of scratches, inclusions, embossing and engravings in glass or plastics.

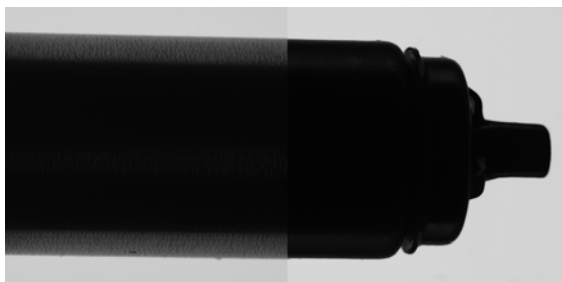

Metal cylinder – diffuse backlight

collimated backlight



Transparent plastic with embossing – diffuse backlight

collimated backlight

\* For a precise definition of terms, see the Glossary on the last page of this Knowledge Base.

# 1.6 Collimated and telecentric backlight

This effect can be enhanced by the use of telecentric backlight lighting. Collimation is achieved by using an optical system in front of a divergent source of light radiation. The beams of light from this telecentric lighting run parallel to one another.

## Telecentric backlight

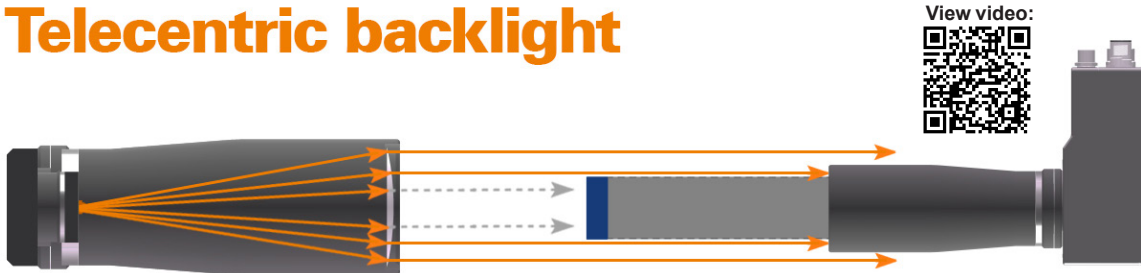

Video can be viewed from <http://www.iimag.de/lumimax/wissenswertes/video-durchlicht-telezentrisch.html>

**LUMIMAX**®

By using a telecentric lens, exactly this parallel light – which runs perpendicular to the plane of the image sensor – is recorded and passed on to the camera. The result is a bright image. If an object is located between the lighting and the lens, this object appears in the image as a perfectly dark body. Edge transitions are clear and extend over only a few pixels from bright to dark. This makes edge probing both straightforward and highly accurate.

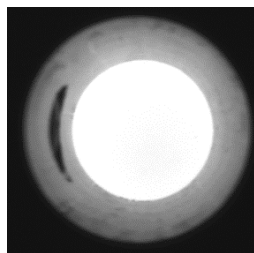

Deep machined hole – diffuse backlight

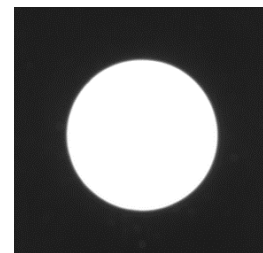

telecentric backlight

As with directed homogeneous backlight lighting, the outlines of transparent objects can be captured as sharp images by using telecentric lighting. Here, the bundle of parallel rays crosses only the perpendicular planes of a body. These appear bright in the image while all other areas are dark. The object's outline is therefore dark in the image. A similar result is achieved with irregularities such as scratches or inclusions in transparent test objects.

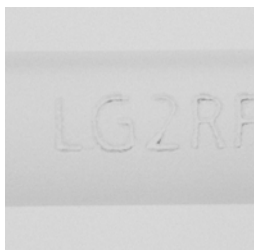

Transparent pen refill – diffuse backlight



telecentric backlight

Use of telecentric lighting also significantly enhances the depth of field and the telecentric region of a telecentric lens.

Influence of the lighting angle

Wavelengths

Optical filters

Flash vs. continuous

Fluorescence applications

Lighting systems for the reading and verification of codes